

PDTC143X series

NPN resistor-equipped transistors; R1 = 4.7 kΩ, R2 = 10 kΩ

Rev. 09 — 26 July 2005

Product data sheet

1. Product profile

1.1 General description

NPN Resistor-Equipped Transistors (RET) family.

Table 1: Product overview

Type number	Package			PNP complement
	Philips	JEITA	JEDEC	
PDTC143XE	SOT416	SC-75	-	PDTA143XE
PDTC143XEF	SOT490	SC-89	-	PDTA143XEF
PDTC143XK	SOT346	SC-59A	TO-236	PDTA143XK
PDTC143XM	SOT883	SC-101	-	PDTA143XM
PDTC143XS ^[1]	SOT54	SC-43A	TO-92	PDTA143XS
PDTC143XT	SOT23	-	TO-236AB	PDTA143XT
PDTC143XU	SOT323	SC-70	-	PDTA143XU

[1] Also available in SOT54A and SOT54 variant packages (see [Section 2](#)).

1.2 Features

- Built-in bias resistors
- Simplifies circuit design
- 100 mA output current capability
- Reduces component count
- Reduces pick and place costs

1.3 Applications

- Digital applications
- Controlling IC inputs
- Cost-saving alternative for BC847 series in digital applications
- Switching loads

1.4 Quick reference data

Table 2: Quick reference data

Symbol	Parameter	Conditions	Min	Typ	Max	Unit
V _{CEO}	collector-emitter voltage	open base	-	-	50	V
I _O	output current		-	-	100	mA
R1	bias resistor 1 (input)		3.3	4.7	6.1	kΩ
R2/R1	bias resistor ratio		1.7	2.1	2.6	

PHILIPS

2. Pinning information

Table 3: Pinning

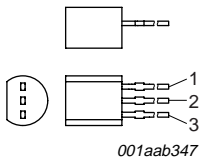
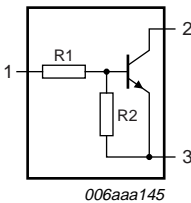
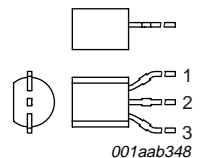
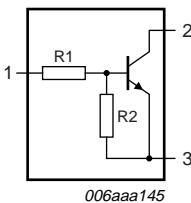
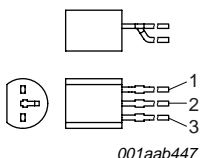
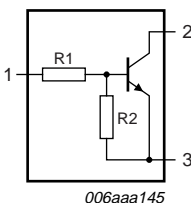
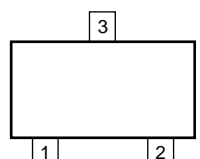
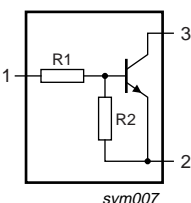
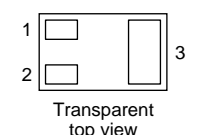
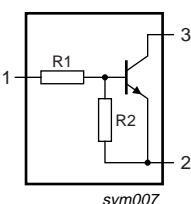
Pin	Description	Simplified outline	Symbol
SOT54			
1	input (base)	 <p>001aab347</p>	 <p>006aaa145</p>
2	output (collector)		
3	GND (emitter)		
SOT54A			
1	input (base)	 <p>001aab348</p>	 <p>006aaa145</p>
2	output (collector)		
3	GND (emitter)		
SOT54 variant			
1	input (base)	 <p>001aab447</p>	 <p>006aaa145</p>
2	output (collector)		
3	GND (emitter)		
SOT23; SOT323; SOT346; SOT416; SOT490			
1	input (base)	 <p>006aaa144</p>	 <p>sym007</p>
2	GND (emitter)		
3	output (collector)		
SOT883			
1	input (base)	 <p>Transparent top view</p>	 <p>sym007</p>
2	GND (emitter)		
3	output (collector)		

3. Ordering information

Table 4: Ordering information

Type number	Package		
	Name	Description	Version
PDTC143XE	SC-75	plastic surface mounted package; 3 leads	SOT416
PDTC143XEF	SC-89	plastic surface mounted package; 3 leads	SOT490
PDTC143XK	SC-59A	plastic surface mounted package; 3 leads	SOT346
PDTC143XM	SC-101	leadless ultra small plastic package; 3 solder lands; body 1.0 × 0.6 × 0.5 mm	SOT883
PDTC143XS ^[1]	SC-43A	plastic single-ended leaded (through hole) package; 3 leads	SOT54
PDTC143XT	-	plastic surface mounted package; 3 leads	SOT23
PDTC143XU	SC-70	plastic surface mounted package; 3 leads	SOT323

[1] Also available in SOT54A and SOT54 variant packages (see [Section 2](#) and [Section 9](#)).

4. Marking

Table 5: Marking codes

Type number	Marking code ^[1]
PDTC143XE	34
PDTC143XEF	54
PDTC143XK	26
PDTC143XM	E2
PDTC143XS	TC143X
PDTC143XT	*32
PDTC143XU	*53

[1] * = -: made in Hong Kong
 * = p: made in Hong Kong
 * = t: made in Malaysia
 * = W: made in China

5. Limiting values

Table 6: Limiting values

In accordance with the Absolute Maximum Rating System (IEC 60134).

Symbol	Parameter	Conditions	Min	Max	Unit	
V_{CBO}	collector-base voltage	open emitter	-	50	V	
V_{CEO}	collector-emitter voltage	open base	-	50	V	
V_{EBO}	emitter-base voltage	open collector	-	7	V	
V_I	input voltage					
	positive		-	+20	V	
	negative		-	-7	V	
I_O	output current		-	100	mA	
I_{CM}	peak collector current	single pulse; $t_p \leq 1$ ms	-	100	mA	
P_{tot}	total power dissipation	$T_{amb} \leq 25$ °C				
	SOT416		[1]	-	150	mW
	SOT490		[1][2]	-	250	mW
	SOT346		[1]	-	250	mW
	SOT883		[2][3]	-	250	mW
	SOT54		[1]	-	500	mW
	SOT23		[1]	-	250	mW
	SOT323		[1]	-	200	mW
	T_{stg}	storage temperature		-65	+150	°C
T_j	junction temperature		-	150	°C	
T_{amb}	ambient temperature		-65	+150	°C	

[1] Device mounted on an FR4 Printed-Circuit Board (PCB), single-sided copper, tin-plated and standard footprint.

[2] Reflow soldering is the only recommended soldering method.

[3] Device mounted on an FR4 PCB with 60 μ m copper strip line, standard footprint.

6. Thermal characteristics

Table 7: Thermal characteristics

Symbol	Parameter	Conditions	Min	Typ	Max	Unit
$R_{th(j-a)}$	thermal resistance from junction to ambient	in free air				
	SOT416		[1] -	-	833	K/W
	SOT490		[1][2] -	-	500	K/W
	SOT346		[1] -	-	500	K/W
	SOT883		[2][3] -	-	500	K/W
	SOT54		[1] -	-	250	K/W
	SOT23		[1] -	-	500	K/W
	SOT323		[1] -	-	625	K/W

[1] Device mounted on an FR4 PCB, single-sided copper, tin-plated and standard footprint.

[2] Reflow soldering is the only recommended soldering method.

[3] Device mounted on an FR4 PCB with 60 μ m copper strip line, standard footprint.

7. Characteristics

Table 8: Characteristics

$T_{amb} = 25^\circ\text{C}$ unless otherwise specified.

Symbol	Parameter	Conditions	Min	Typ	Max	Unit
I_{CBO}	collector-base cut-off current	$V_{CB} = 50\text{ V}; I_E = 0\text{ A}$	-	-	100	nA
I_{CEO}	collector-emitter cut-off current	$V_{CE} = 30\text{ V}; I_B = 0\text{ A}$	-	-	1	μ A
		$V_{CE} = 30\text{ V}; I_B = 0\text{ A}; T_j = 150^\circ\text{C}$	-	-	50	μ A
I_{EBO}	emitter-base cut-off current	$V_{EB} = 5\text{ V}; I_C = 0\text{ A}$	-	-	600	μ A
h_{FE}	DC current gain	$V_{CE} = 5\text{ V}; I_C = 10\text{ mA}$	50	-	-	
V_{CEsat}	collector-emitter saturation voltage	$I_C = 10\text{ mA}; I_B = 0.5\text{ mA}$	-	-	100	mV
$V_{I(off)}$	off-state input voltage	$V_{CE} = 5\text{ V}; I_C = 100\text{ }\mu\text{A}$	-	-	0.3	V
$V_{I(on)}$	on-state input voltage	$V_{CE} = 300\text{ mV}; I_C = 20\text{ mA}$	2.5	-	-	V
R1	bias resistor 1 (input)		3.3	4.7	6.1	k Ω
R2/R1	bias resistor ratio		1.7	2.1	2.6	
C_c	collector capacitance	$V_{CB} = 10\text{ V}; I_E = i_e = 0\text{ A}; f = 1\text{ MHz}$	-	-	2.5	pF

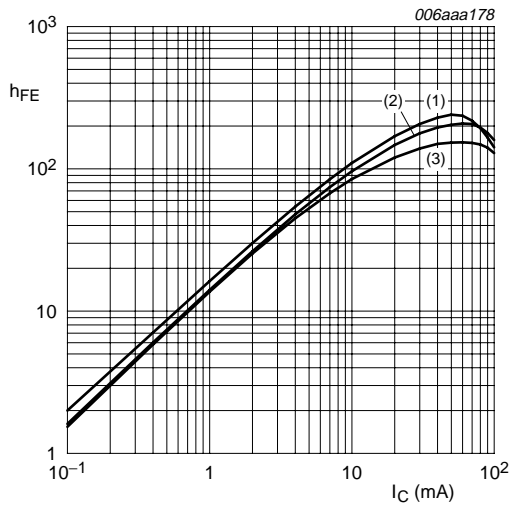

$V_{CE} = 5 \text{ V}$

- (1) $T_{amb} = 100 \text{ }^\circ\text{C}$
- (2) $T_{amb} = 25 \text{ }^\circ\text{C}$
- (3) $T_{amb} = -40 \text{ }^\circ\text{C}$

Fig 1. DC current gain as a function of collector current; typical values

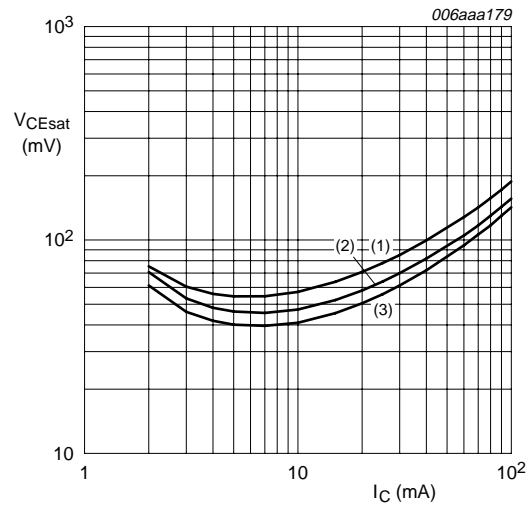

$I_C/I_B = 20$

- (1) $T_{amb} = 100 \text{ }^\circ\text{C}$
- (2) $T_{amb} = 25 \text{ }^\circ\text{C}$
- (3) $T_{amb} = -40 \text{ }^\circ\text{C}$

Fig 2. Collector-emitter saturation voltage as a function of collector current; typical values

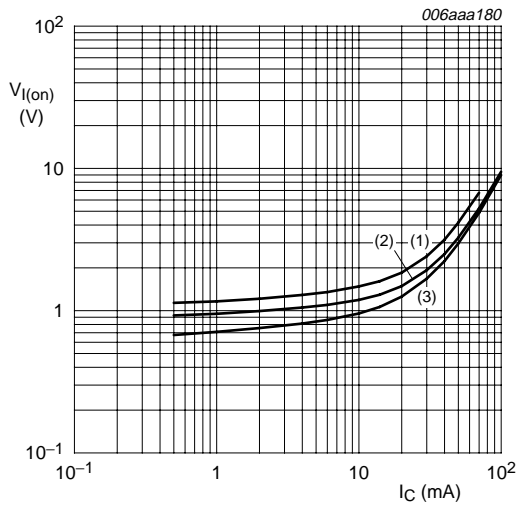

$V_{CE} = 0.3 \text{ V}$

- (1) $T_{amb} = -40 \text{ }^\circ\text{C}$
- (2) $T_{amb} = 25 \text{ }^\circ\text{C}$
- (3) $T_{amb} = 100 \text{ }^\circ\text{C}$

Fig 3. On-state input voltage as a function of collector current; typical values

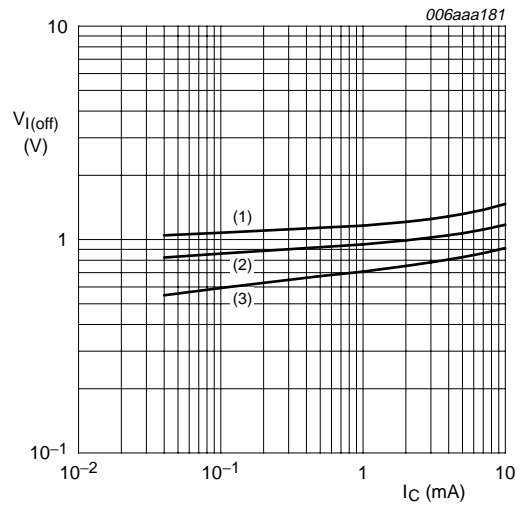

$V_{CE} = 5 \text{ V}$

- (1) $T_{amb} = -40 \text{ }^\circ\text{C}$
- (2) $T_{amb} = 25 \text{ }^\circ\text{C}$
- (3) $T_{amb} = 100 \text{ }^\circ\text{C}$

Fig 4. Off-state input voltage as a function of collector current; typical values

8. Package outline

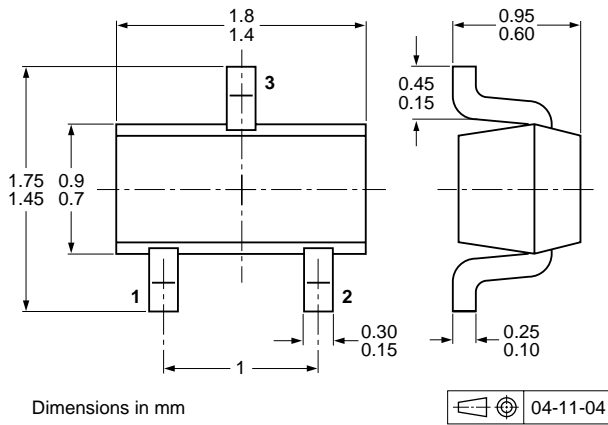

Fig 5. Package outline SOT416 (SC-75)

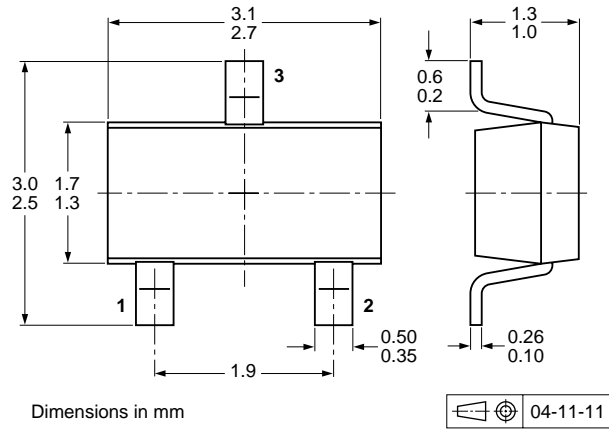

Fig 6. Package outline SOT346 (SC-59A/TO-236)

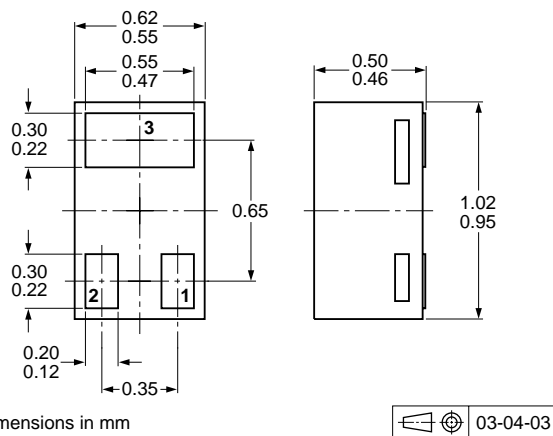

Fig 7. Package outline SOT883 (SC-101)

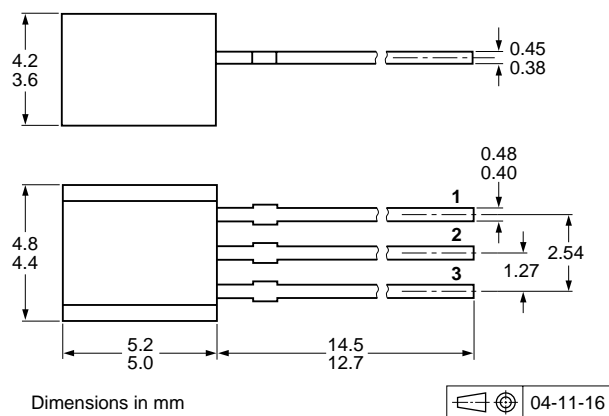

Fig 8. Package outline SOT54 (SC-43A/TO-92)

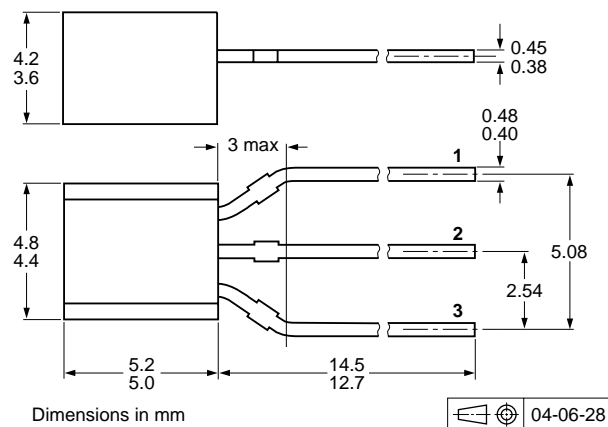

Fig 9. Package outline SOT54A

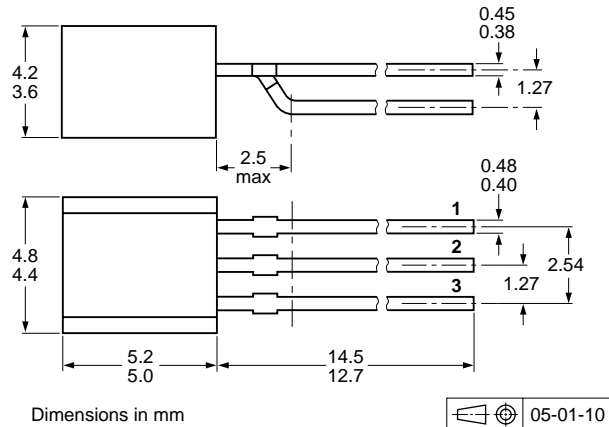

Fig 10. Package outline SOT54 variant

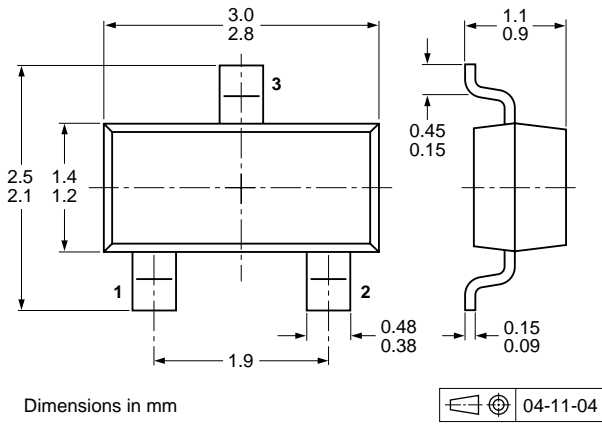

Fig 11. Package outline SOT23 (TO-236AB)

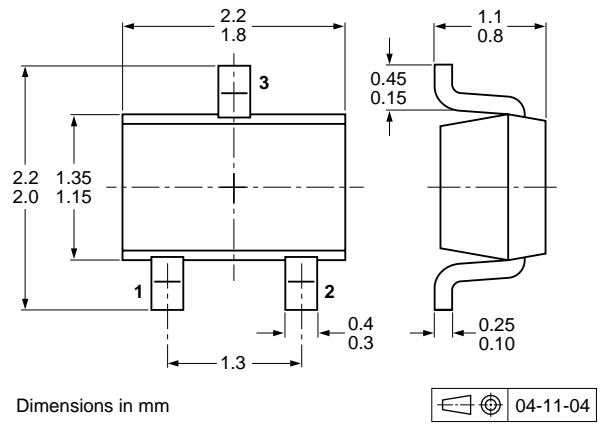

Fig 12. Package outline SOT323 (SC-70)

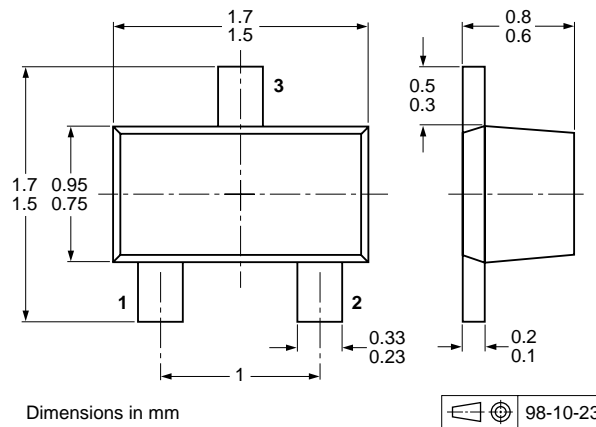

Fig 13. Package outline SOT490 (SC-89)

9. Packing information

Table 9: Packing methods

The indicated -xxx are the last three digits of the 12NC ordering code. [1]

Type number	Package	Description	Packing quantity			
			3000	4000	5000	10000
PDTC143XE	SOT416	4 mm pitch, 8 mm tape and reel	-115	-	-	-135
PDTC143XEF	SOT490	4 mm pitch, 8 mm tape and reel	-	-115	-	-
PDTC143XK	SOT346	4 mm pitch, 8 mm tape and reel	-115	-	-	-135
PDTC143XM	SOT883	2 mm pitch, 8 mm tape and reel	-	-	-	-315
PDTC143XS	SOT54	bulk, straight leads	-	-	-412	-
	SOT54A	tape and reel, wide pitch	-	-	-	-116
		tape ammopack, wide pitch	-	-	-	-126
	SOT54 variant	bulk, delta pinning	-	-	-112	-
PDTC143XT	SOT23	4 mm pitch, 8 mm tape and reel	-215	-	-	-235
PDTC143XU	SOT323	4 mm pitch, 8 mm tape and reel	-115	-	-	-135

[1] For further information and the availability of packing methods, see [Section 15](#).

10. Revision history

Table 10: Revision history

Document ID	Release date	Data sheet status	Change notice	Doc. number	Supersedes
PDTC143X_SER_9	20050726	Product data sheet	-	-	PDTC143X_SERIES_8
Modifications:	<ul style="list-style-type: none"> • The format of this data sheet has been redesigned to comply with the new presentation and information standard of Philips Semiconductors. • Section 1.2 “Features”: amended • Section 1.3 “Applications”: amended • Table 6 “Limiting values”: typing error for value of V_{EBO} emitter-base voltage corrected • Table 8 “Characteristics”: $V_{i(on)}$ redefined to $V_{I(on)}$ on-state input voltage • Table 8 “Characteristics”: $V_{i(off)}$ redefined to $V_{I(off)}$ off-state input voltage • Figure 1, 2, 3, 4, 9 and 10: added • Figure 5, 6, 7, 8, 11, 12 and 13: superseded by minimized package outlines • Section 9 “Packing information”: added • Section 14 “Trademarks”: added 				
PDTC143X_SERIES_8	20040806	Product specification	-	9397 750 13676	PDTC143X_SERIES_7
PDTC143X_SERIES_7	20040323	Product specification	-	9397 750 12962	PDTC143X_SERIES_6
PDTC143X_SERIES_6	20040112	Product specification	-	9397 750 12444	PDTC143X_SERIES_5
PDTC143X_SERIES_5	20031112	Product specification	-	9397 750 12196	PDTC143X_SERIES_4
PDTC143X_SERIES_4	20030910	Product specification	-	9397 750 11736	PDTC143X_SERIES_3
PDTC143X_SERIES_3	20030410	Product specification	-	9397 750 11022	PDTC143XE_2 PDTC143XK_1 PDTC143XT_1
PDTC143XE_2	19990521	Product specification	-	9397 750 05865	PDTC143XE_1
PDTC143XE_1	19980529	Product specification	-	9397 750 03914	-
PDTC143XK_1	20020115	Product specification	-	9397 750 09147	-
PDTC143XT_1	19990420	Product specification	-	9397 750 04931	-

11. Data sheet status

Level	Data sheet status ^[1]	Product status ^{[2] [3]}	Definition
I	Objective data	Development	This data sheet contains data from the objective specification for product development. Philips Semiconductors reserves the right to change the specification in any manner without notice.
II	Preliminary data	Qualification	This data sheet contains data from the preliminary specification. Supplementary data will be published at a later date. Philips Semiconductors reserves the right to change the specification without notice, in order to improve the design and supply the best possible product.
III	Product data	Production	This data sheet contains data from the product specification. Philips Semiconductors reserves the right to make changes at any time in order to improve the design, manufacturing and supply. Relevant changes will be communicated via a Customer Product/Process Change Notification (CPCN).

[1] Please consult the most recently issued data sheet before initiating or completing a design.

[2] The product status of the device(s) described in this data sheet may have changed since this data sheet was published. The latest information is available on the Internet at URL <http://www.semiconductors.philips.com>.

[3] For data sheets describing multiple type numbers, the highest-level product status determines the data sheet status.

12. Definitions

Short-form specification — The data in a short-form specification is extracted from a full data sheet with the same type number and title. For detailed information see the relevant data sheet or data handbook.

Limiting values definition — Limiting values given are in accordance with the Absolute Maximum Rating System (IEC 60134). Stress above one or more of the limiting values may cause permanent damage to the device. These are stress ratings only and operation of the device at these or at any other conditions above those given in the Characteristics sections of the specification is not implied. Exposure to limiting values for extended periods may affect device reliability.

Application information — Applications that are described herein for any of these products are for illustrative purposes only. Philips Semiconductors make no representation or warranty that such applications will be suitable for the specified use without further testing or modification.

13. Disclaimers

Life support — These products are not designed for use in life support appliances, devices, or systems where malfunction of these products can reasonably be expected to result in personal injury. Philips Semiconductors

15. Contact information

For additional information, please visit: <http://www.semiconductors.philips.com>

For sales office addresses, send an email to: sales.addresses@www.semiconductors.philips.com

customers using or selling these products for use in such applications do so at their own risk and agree to fully indemnify Philips Semiconductors for any damages resulting from such application.

Right to make changes — Philips Semiconductors reserves the right to make changes in the products - including circuits, standard cells, and/or software - described or contained herein in order to improve design and/or performance. When the product is in full production (status 'Production'), relevant changes will be communicated via a Customer Product/Process Change Notification (CPCN). Philips Semiconductors assumes no responsibility or liability for the use of any of these products, conveys no license or title under any patent, copyright, or mask work right to these products, and makes no representations or warranties that these products are free from patent, copyright, or mask work right infringement, unless otherwise specified.

14. Trademarks

Notice — All referenced brands, product names, service names and trademarks are the property of their respective owners.

16. Contents

1	Product profile	1
1.1	General description	1
1.2	Features	1
1.3	Applications	1
1.4	Quick reference data	1
2	Pinning information	2
3	Ordering information	3
4	Marking	3
5	Limiting values	4
6	Thermal characteristics	5
7	Characteristics	5
8	Package outline	7
9	Packing information	9
10	Revision history	10
11	Data sheet status	11
12	Definitions	11
13	Disclaimers	11
14	Trademarks	11
15	Contact information	11



© Koninklijke Philips Electronics N.V. 2005

All rights are reserved. Reproduction in whole or in part is prohibited without the prior written consent of the copyright owner. The information presented in this document does not form part of any quotation or contract, is believed to be accurate and reliable and may be changed without notice. No liability will be accepted by the publisher for any consequence of its use. Publication thereof does not convey nor imply any license under patent- or other industrial or intellectual property rights.

Date of release: 26 July 2005
Document number: PDTC143X_SER_9

Published in The Netherlands